

PON Optical power meter  
USER'S GUIDE

English

## WARNING

You are cautioned that changes or modifications not expressly approved in this document could void your authority to operate this equipment.

To reduce the risk of fire or electric shock, do not expose this apparatus to rain or moisture.

To avoid electrical shock, do not open the cabinet. Refer servicing to qualified personnel only.

## NOTE

As the laser is harmful to the eyes, do not attempt to disassemble the cabinet.



## Precautions for Use

### Use batteries

At the same time, can not use different style or different capacitance batteries.

And only charge the rechargeable batteries.

### Avoiding condensation problems

As much as possible, avoid sudden temperature changes. Do not attempt to use the drive immediately after moving it from a cold to a warm location, to raising the room temperature suddenly, as condensation may form within the drive. If the temperature changes suddenly while using the drive,

Stop using it and take out batteries for at least an hour.

### Storage

When long time no use, must take out the batteries to avoid destroying the device.

---

## Standard

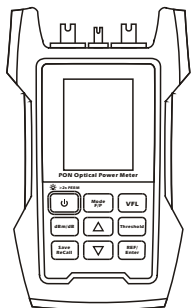

Host

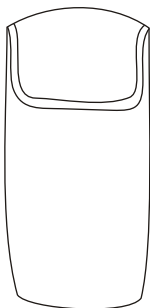

Packet



User's Guide

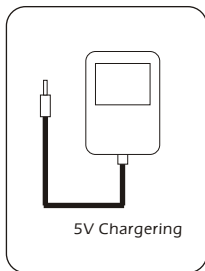

5V Charging

Optional

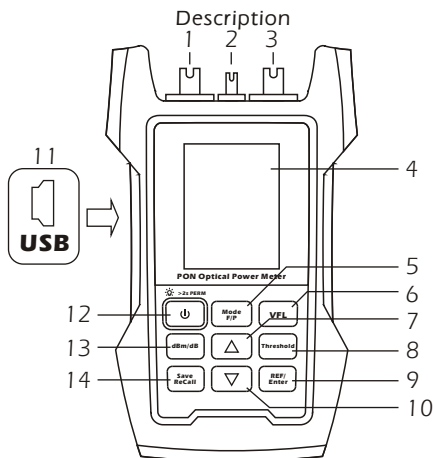

1-ONT (1310nm) connector

2-VFL/OPM connector

3-OLT/Video(1490/1550nm) connector

4-LCD display screen

5-F/P mode (PASS, WRNG, FAIL)/ main menu button

6-VFL controlling button

7-Up button

8-Threshold selection menu and calibration menu button

9-Reference setting button

10-Down button

11-USB and data communication interface 12-Power and backlight button

---

## Installing the battery

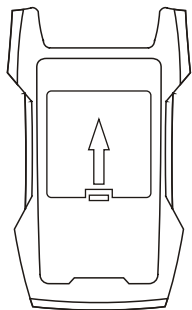

1. Pull the battery cover lock

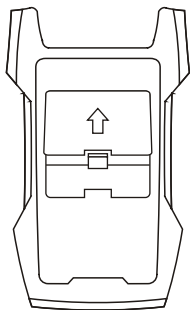

2. Raise the battery cover

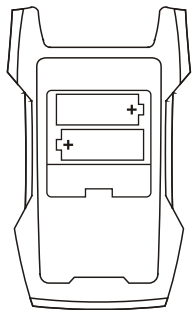

3. Installing the battery correctly

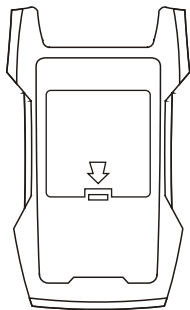

4. Push the battery cover and lock

## On/Off and Permanent On

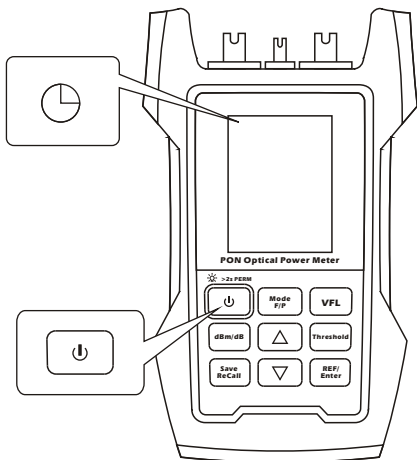

Press the Power key to turn on the device with auto power off. After 10 minutes no keypressed, it will auto power off.

Press Powerkey for 2 seconds when turn on the device, the auto power off will be cancelled, and the LCD will show

“  ” .

Also press it for more than 2 seconds to shut the device.

## Function selection

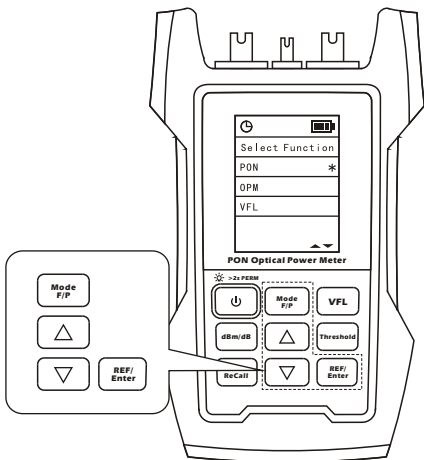

According to different configuration, OPM or VFL as optional part can be built in the PON meter. Without OPM or VFL, it will show "NO".

After booting, the meter shows function selection menu. Press Up button or Down button to switch functions. Then press “ **REF/Enter** ” button to enter corresponding interface. If you want to select functions again, only need to press “ **Mode F/P** ” button for two seconds or more, and you can return to function selection menu.

---

## Connection diagram of PON network online testing

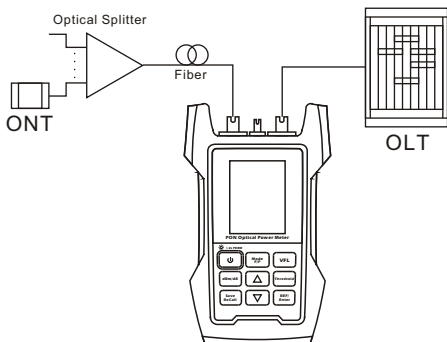

### Testing configuration diagram of OLT port sending optical power averagely

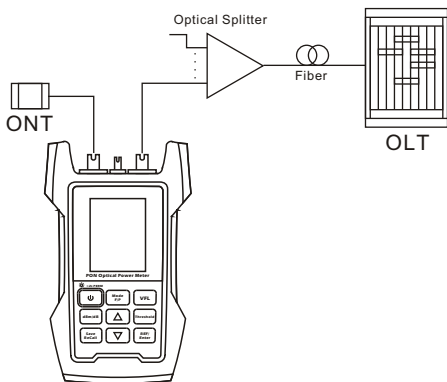



### Testing configuration diagram of ONT Port sending optical power averagely



---

## PON optical power meter

	
<b>ONU: 1310nm</b>	
-28.56	dBm
<b>OLT: 1490nm</b>	
-11.21	dBm
<b>VDO: 1550nm</b>	
LOW	

After entering PON power meter function, it will show a testing interface on the screen. PON power meter can measure uplink signal 1310nm, downlink data signal 1490nm and downlink video signal 1550nm in the PON network at the same time.

HI and LOW mean the result is out of the testing range.

## PON optical power meter - quick judgement

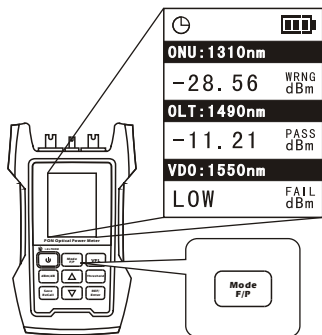

Quick judgment mode is a comparison between actual measured data and pre-setting threshold. Then device can quickly judge whether the network meets the communication requirement or not. (Threshold setting is described in detail in the chapters followed.)

Press “  ” button to open or close the alarm function (PASS, WRNG, FAIL) On LCD there are warning words beside the result And the LED of each wavelength will turn on:

RED LED: FAIL

ORANGE LED: WRNG

GREEN LED: PASS

## PON optical power meter - reference setting

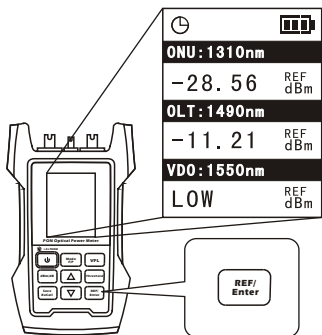

Setting reference is usually used before measuring the real network. It can wipe off the attenuation value which is not counted in the actual loss. Or it can be used in comparing with the pre-setting standard power.

“  ” Button is used to setting or checking out the reference value. Short press it, the screen will show "REF" and a pre-setting dBm value. Long press it for two seconds or more, the device will save the current measured value as a new reference value. At the same time, "REF" sign will flash three times on the display screen. After that, it will show the dB value, and three wavelengths will be set simultaneously.

## PON optical power meter - threshold and offset (calibration) setting

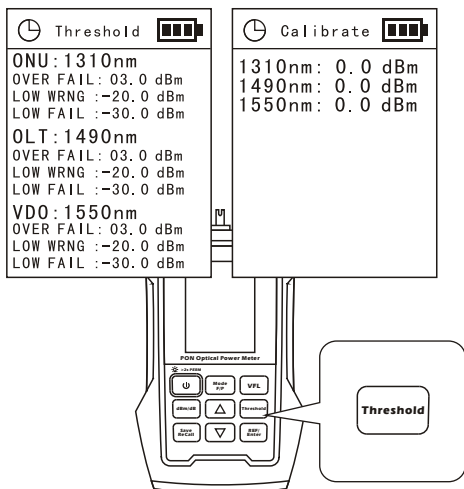

The threshold is set to quickly detect whether the result is in range or not, and to confirm whether the network can be used or not. The offset value is set to calibrate the regular attenuation or deviation between standard value and measured value

Short press “ **Threshold** ” button, it will enter into threshold setting menu. Press again, it will enter into calibration menu.

## PON optical power meter - threshold setting

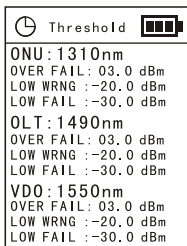



After entering threshold setting menu, the cursor will default stay on the threshold number. Firstly, you should choose the threshold number which you need to set or modify through pressing “  ” button. The device can set 10 groups of threshold information.

When start quick judgment mode, it will show the current referring threshold number on the top of the display screen, in the form of “Tx”.

When finish choosing threshold number, you can set corresponding parameters through Up button, Down button and “  ” button. Each channel has three parameters. For example, 1310nm includes parameters as followed:

ONU : 1310nm	Wavelengths be set
OVER FAIL : 03.0 dBm	Upper limit (Over this power can not communicate)
LOW WRNG : -20.0 dBm	Lower limit warning (Close to non-communication)
LOW FAIL : -30.0 dBm	Lower limit (Below this power can not communicate)

When the cursor move to the corresponding parameter, press “  ” button, it can shift to each data. Press Up button or Down button to modify. Then press “  ” button until the whole data change to cursor, which means modifying successfully. After finishing setting, press “  ” button to back to the testing interface.

---

## PON optical power meter - offset(calibration) setting

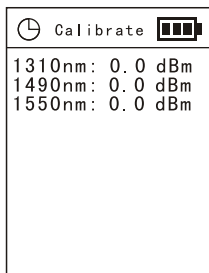





The followings will cause the test result difference:

1. Different standard
2. Not use standard accessories. (Lab level 0 dB adapter, 0 dB patch cord)
3. Dirty of connector
4. More than 1 year no calibration

User can do easy calibration as the following steps:



Press the "  " key to the calibration menu as the picture.

1. Press the "  " key to move the cursor.
2. Press the "  " key to increase the value
3. Press the "  " key to decrease the value
4. Press again the "  " key to save and exit.

Please note the adjustable range of each wavelength is from -5.0 to +5.0, if the difference is out of the range, we suggest users send back to manufacturer to do completely calibration.

---

## PON optical power meter - data storage

 8/100 
<b>ONU: 1310nm</b>
-28.56 dBm
<b>OLT: 1490nm</b>
-11.21 dBm
<b>VDO: 1550nm</b>
LOW dBm

The measured data storage is used to record the important measured data, which can be used to analysis after measuring.



Under measurement interface, press “  ” button can display the saved historical data. Press Up or Down button can browse records and show the data number on the top of the screen. Press this button for two seconds under current interface, the number will be showed on the upper left of the screen and store the current measured data (by dBm value).

The device can store 100 records at most. The data number will plus 1 automatically. If stores fully, the device will overwrite the first record automatically. Successively store data as above-mentioned.

Press “  ” button again, back to measurement interface.

---

## PON optical power meter- display unit

	
<b>ONU: 1310nm</b>	
100.10	uW
<b>OLT: 1490nm</b>	
400.33	uW
<b>VDO: 1550nm</b>	
210.62	uW

The measured data will be display in dBm value and uW value. Press “  ” button can switch display unit.



---

## Optical power meter

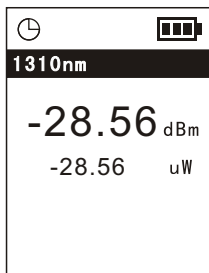

Optical power meter mode is a superior optical power meter with storage function. The dBm value and uW value show simultaneously, operations as followed:

**Threshold** Press to switch the measured wavelengths, calibration wavelengths are: 850/1300/1310/1490/1550/1625nm



**REF/Enter** Short press can check the saved references of six calibration wavelengths above-mentioned. Long press this button can save current value as a reference.

**Save ReCall** Device can store 100 records. Short press can check 10 records and press Up or Down button can turn pages. Long press can save current data to device. The data number will plus 1 automatically. If stores fully, the device will overwrite the first record automatically. Successively store data as above-mentioned.

---

## VFL



Visual Fault Locator(VFL) is used to seek the failure point in bare fiber and cables, including rupture, fiber loss, connector seeking and so on. Press “” button, the laser will flash or keep on bright. You can use VFL both in PON power meter mode and optical power meter mode. Press “” button can control laser open, close and flash, which will be shown on the screen by "\*" symbol.

---

## Batteries detecting and charging

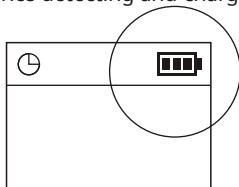

### Four levels indication of power detection



Represents the remaining 80%---100% electricity



Represents the remaining 40%---80% electricity



Represents the remaining 20%---40% electricity



Represents the remaining electricity less than 20%

After connecting the USB charger, a charging icon shows on the screen. If there are rechargeable batteries in the device, it starts charging the rechargeable batteries. Forbid using non-rechargeable batteries to charge, or it might lead to leakage, even burning.

When the remaining electricity is less than 20%, you should promptly shut down the device and recharge it. Long time undervoltage will shorten the lifetime of the rechargeable batteries. When the charging is finished, the battery remaining indicator will stop flashing. The batteries has finished the fast recharge and can be used directly. If you do not stop recharging at this time, the device will continue the trickle charge state, using small current to supply natural discharge. But this process is not more than 24 hours. The device can still be used while charging.

## Detail parameters

1310nm Uplink test	
Spectrum passband	1260nm~1360nm
Measurement range	-40dBm~+10dBm
Max. permitted input level	15dBm
Isolation (for 1490/1550nm)	>40dB
Accurate Of Burst Signal	Deviation <math>\lt; \pm 0.5\text{dB}</math>@-10dBm
1490nm Downlink test	
Spectrum passband	1480nm~1500nm
Measurement range	-50dBm~+10dBm
Max. permitted input level	15dBm
Isolation (for 1310nm)	>40dB
Isolation (for 1550nm)	>40dB
1550nm Downlink test	
Spectrum passband	1530nm~1570nm
Measurement range	-50dBm~+25dBm
Max. permitted input level	25dBm
Isolation (for 1310nm)	>40dB
Isolation (for 1490nm)	>40dB
Optical fiber type	SM 9/125um
Optical fiber connector	SC/PC or customized
Accurate	$\pm 0.2\text{dB}/ \pm 0.5\text{dB}$ (burst mode)
Linearity	0.1dB
Inserting loss	<1.5dB
Applicable batteries	AA x 3 or AC/DC adapter (220V)
Battery lifetime	about 36 hours
Charging function	Included
Auto power off	Included
Operation temperature	-10~+50°C
Storage temperature	-20~+60°C
Relative humidity	0 -- 90%, No condensation
Weight	about 450g
Size	40mm*90mm*190mm

## Detail parameters

### VFL part

Centre wavelength	650nm
Out put power	
Option 1	1mW
Option 2	10mW
Option 3	15mW
Option 4	20mW
Option 5	25mW
Option 6	30mW
Optical fiber adapter	2.5mmUPP

### Measurement range

Measurement range	
Option 1	-70dBm~ +8dBm
Option 2	-60dBm~ +18dBm
Option 3	-50dBm~ +26dBm
Resolution	0.01dB
Accuracy	$\pm 0.2$ dB
Linearity	$\pm 2\%$
Detector type	InGaAs
Optical fiber adapter	FC/Universal connector
Wavelength response range	700~1700nm
Calibration wavelength	850/1300/1310/1490/1550/1625nm

### Selection guide

Option 1	Standard PON Optical powermeter
Option 2	Standard PON Optical powermeter+Optical power meter(-70~ +8dBm)
Option 3	Standard PON Optical powermeter+Optical power meter(-60~ +18dBm)
Option 4	Standard PON Optical powermeter+Optical power meter(-50~ +26dBm)
Option 5	Standard PON Optical powermeter+ 1mW VFL
Option 6	Standard PON Optical powermeter+ 10mW VFL
Option 7	Standard PON Optical powermeter+ 15mW VFL
Option 8	Standard PON Optical powermeter+20mW VFL
Option 9	Standard PON Optical powermeter+25mW VFL
Option 10	Standard PON Optical powermeter+30mW VFL